

TEST EQUIPMENT PLUS

Signal Hound BB60A

User Manual

TEST EQUIPMENT PLUS

Signal Hound BB60A User Manual

© 2013, Test Equipment Plus
35707 NE 86th Ave
La Center, WA
Phone 360.263.5006 • Fax 360.263.5007

Table of Contents

1	PREPARATION	3
1.1	INITIAL INSPECTION	3
1.2	SOFTWARE INSTALLATION.....	3
1.2.1	<i>Software Requirements</i>	3
1.3	DRIVER INSTALLATION	4
1.4	CONNECTING YOUR SIGNAL HOUND.....	4
1.5	RUNNING THE SOFTWARE FOR THE FIRST TIME.....	5
1.6	THE BB60A FRONT AND REAR PANELS.....	5
2	GETTING STARTED.....	6
2.1	THE GRATICULE	6
2.2	THE CONTROL PANEL	6
2.2.1	<i>Frequency Controls</i>	7
2.2.2	<i>Span Controls</i>	7
2.2.3	<i>Amplitude Controls</i>	7
2.2.4	<i>Bandwidth Controls</i>	7
2.2.5	<i>Marker Controls</i>	8
2.2.6	<i>Trace Controls</i>	8
2.2.7	<i>Trigger Controls</i>	8
2.2.8	<i>Video Processing</i>	8
2.2.9	<i>Acquisition Controls</i>	9
2.2.10	<i>Preset</i>	9
2.3	THE MENU.....	9
2.3.1	<i>File Menu</i>	9
2.3.2	<i>View Menu</i>	10
2.3.3	<i>Preferences</i>	10
2.3.4	<i>Presets</i>	10
2.3.5	<i>Settings</i>	10
2.3.6	<i>Spectrum Analysis</i>	11
2.3.7	<i>Trace</i>	11
2.3.8	<i>Utilities</i>	11
2.4	THE STATUS BAR	11
2.5	ANNUNCIATOR LIST.....	12
2.6	PLAYBACK TOOLBAR.....	12
3	MODES OF OPERATION	13
3.1	SWEPT ANALYSIS	13
3.2	REAL-TIME SPECTRUM ANALYSIS	13
3.3	ZERO-SPAN ANALYSIS.....	15

3.4	TIME-GATE ANALYSIS.....	16
4	TAKING MEASUREMENTS.....	17
4.1	MEASURING FREQUENCY AND AMPLITUDE	17
4.1.1	<i>Using Markers</i>	17
4.1.2	<i>Using the Delta Marker</i>	17
4.1.3	<i>Measuring Low Level Signals</i>	17
4.2	SAVING SESSIONS	17
4.3	CAPTURING SIGNALS OF INTEREST.....	18
4.4	MEASURING CHANNEL POWER.....	18
5	ADDITIONAL FEATURES	19
5.1	PRINTING.....	19
5.2	SAVING IMAGES	20
5.3	IMPORTING PATH LOSS AND LIMIT LINE TABLES.....	20
6	DISPLAY MODES	22
6.1	SPECTROGRAM.....	22
6.2	PERSISTENCE.....	22
7	UNDERSTANDING THE BB60A HARDWARE.....	24
7.1	FRONT END ARCHITECTURE	24
7.2	SPURIOUS SIGNALS	24
7.3	RESIDUAL SIGNALS.....	25
7.4	AMPLITUDE ACCURACY.....	25
7.4.1	<i>Scalloping Loss</i>	25
7.5	DYNAMIC RANGE.....	25
8	TROUBLESHOOTING	27
8.1	UNABLE TO FIND OR OPEN THE DEVICE.....	27
8.1.1	<i>The Device Light is Green and Still Won't Connect</i>	27
8.1.2	<i>A Power Cycle Does Not Fix the Problem</i>	27
8.2	THE SIGNAL HOUND IS NOT SWEEPING PROPERLY	27
8.2.1	<i>The Sweep is not Updating</i>	27
8.3	THE DEVICE IS NOT VALID	27
9	CALIBRATION AND ADJUSTMENT.....	28
10	SPECIFICATIONS	29
10.1	FREQUENCY:.....	29
10.2	SWEEP RATE.....	29
10.3	AMPLITUDE (RBW \leq 100KHz, IF AUTO-CAL ON).....	29
10.4	SPECTRAL PURITY	30
10.5	TIMING.....	30
10.6	ENVIRONMENTAL	30
11	WARRANTY AND DISCLAIMER.....	31
11.1	WARRANTY	31
11.2	WARRANTY SERVICE	31
11.3	LIMITATION OF WARRANTY	31
11.4	EXCLUSIVE REMEDIES	31
11.5	CERTIFICATION.....	32
11.6	CREDIT NOTICE	32

1 Preparation

The BB60A is a real-time high speed spectrum analyzer communicating with your PC over a USB 3.0 Super Speed link. It has 20 MHz of real-time bandwidth, tunes from 9 kHz to 6 GHz, collects 80 million samples per second, and streams data to your computer at 140 MB/sec. By adding a high speed hard drive to your PC or laptop (250 MB/s sustained write speed), the BB60A doubles as an RF recorder, streaming all 80 million samples per second to disk.



1.1 Initial Inspection

Check your package for shipping damage before opening. Your box should contain a USB 3.0 Y-cable, a CD-ROM, and a Signal Hound BB60A.

1.2 Software Installation

Run the **setup.exe** file from the included CD, and follow on-screen instructions. You must have administrator privileges to install the software. You may be asked to install the Windows Runtime Frameworks, as this must be installed for the software to run. During installation, the BB60A device drivers will also be installed.

It is recommended to install the application folder in the default location.

1.2.1 Software Requirements Supported Operating Systems

- Windows 7 (64-bit)*

PREPARATION

- Windows 8 (64-bit)

Minimum System Requirements

- Processor – Intel Desktop quad-core i-Series processors***
- RAM – 1 GB for the BB60A software
- Native USB 3.0 support

Recommended System Requirements

- Windows 7 64-bit
- Processor – Intel Desktop quad-core i5 / i7 processors
- 8 GB RAM
- Native USB 3.0 support
- OpenGL 3.0 capable graphics processor**

(* Contact Test Equipment Plus for 32-bit operating system drivers.)

(** Certain display features are accelerated with this functionality, but it is not required.)

(*** Our software is highly optimized for Intel CPUs. We recommend them exclusively.)

1.3 Driver Installation

The drivers shipped for the BB60A are for 64-bit operating systems and are placed in the application folder during installation. The drivers should install automatically during setup. If for some reason the drivers did not install correctly, you can manually install them by following the instructions below.

To manually install the drivers, navigate to the application folder (where you installed the BB60A software) and find the **InstallDrivers64.exe** file. Right click it and **Run as administrator**. The console text will tell you if the installation was successful.

You may also manually install the drivers through the Windows device manager. On Windows 7 systems with the device plugged in, click the **Start Menu** and **Device and Printers**. Find the FX3 unknown USB 3.0 device and right click the icon and select **Properties**. From there select the **Hardware** tab and then **Properties**. Select the **Change Settings** button. Hit the **Update Drivers** button and then **Browse My Computer** for drivers. From there navigate to the BB60A application folder and select the folder name **drivers**. Hit OK and wait for the drivers to install.

If for some reason the drivers still did not install properly, contact Test Equipment Plus.

1.4 Connecting Your Signal Hound

With the software and BB60A drivers installed, you are ready to connect your device. Plug in both male USB 3.0 connections into your PC's USB 3.0 ports, and plug the USB 3.0 Micro-B male connection into the BB60A device. Your PC may take a few seconds recognizing the device and installing any last drivers. Wait for this process to complete before launching the BB60A software.

1.5 Running the Software for the First Time

Once the software and drivers are installed you can launch the software. You can do this through the desktop shortcut created or the **BB60A.exe** found in the application folder. If the device is connected a progress bar will indicate the device preparing. If no device is connected or found, the software will notify you. At this point, connect the device and use the **File->Connect Device** menu option to open the device.

1.6 The BB60A Front and Rear Panels

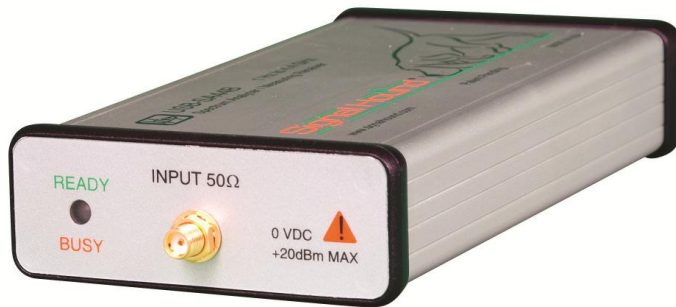

The **front panel** includes a 50Ω SMA RF Input. Do not exceed +20 dBm or damage may occur. A READY/BUSY LED flashes orange each time a command from the computer is processed.

The **rear panel** has three connectors:

- 1) 10 MHz Reference input / output. Use a clean 10 MHz reference sine wave or square wave with >0 dBm level. A +13 dBm sine wave input or 3.3V CMOS clock input is recommended.
- 2) A USB 3.0 Micro-B female connector. Use the Y-cable provided to connect the device to your PC.
- 3) A multi-purpose BNC connector, primarily for trigger input.

Both BNC connectors are also capable of outputting logic high and low using the API.

2 Getting Started

Learn about the basic functions and features of your Signal Hound Spectrum Analyzer.

Launching the BB60A software brings up the Graphical User Interface (GUI). This section describes the GUI in detail and how you can use the GUI to control the BB60A.

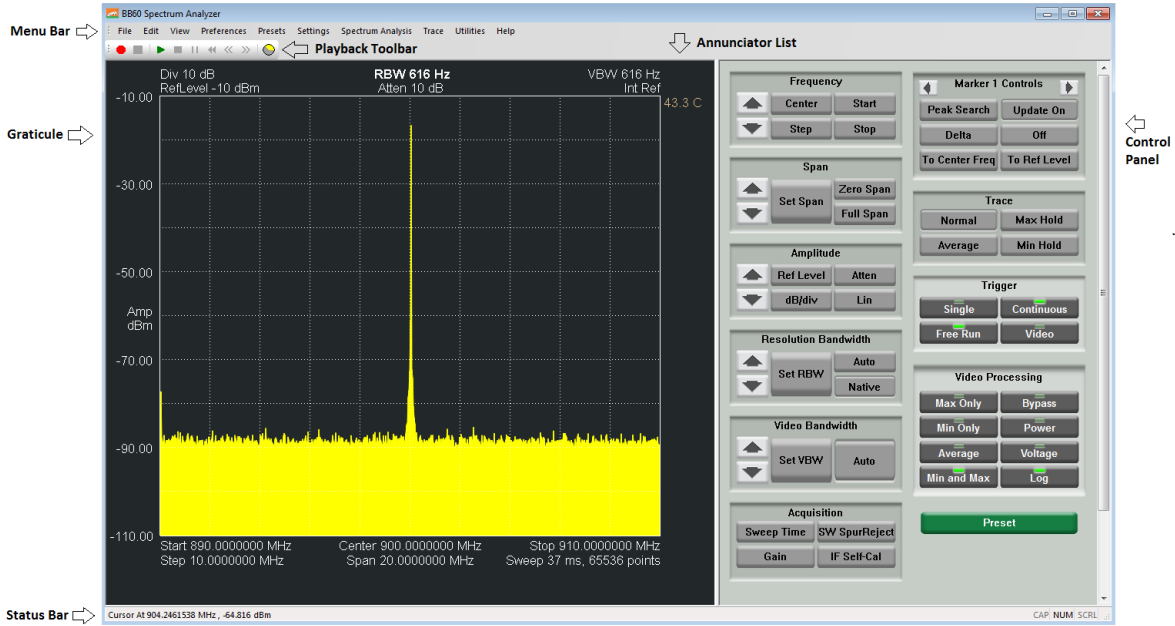

Figure 1: The BB60A Graphical User Interface

2.1 The Graticule

The graticule is a grid of squares used as a reference when displaying sweeps and when making measurements. The BB60A displays a ten by ten grid. Inside and around the graticule is text which can help you make sense of the graticule and the sweeps displaying within.

Outside the graticule in the upper right corner is displayed the temperature of the device in degrees Celsius. An “Uncal” annunciator will appear above the temperature when the device readings may be out of spec due to a recent temperature shift.

2.2 The Control Panel

The control panel is the collection of buttons on the right hand side of the Graphical User Interface. It is home to many common controls. You will recognize many of these controls if you have used a standard spectrum analyzer. Any control which requires an input value will provide a pop-up dialog box for numeric entry and relevant unit selection.

2.2.1 Frequency Controls

- **Center** – allows you to change the center frequency of the sweep. If a change in center frequency causes the start or stop frequencies to fall outside the range of operation, the SPAN will be reduced.
- **Start/Stop** – allows you to change the sweeps start and stop frequencies respectively. Frequencies chosen outside the range of operation (9 kHz – 6.5 GHz) are clamped.
- **Step** – allows you to change the step amount of the up and down arrows. The default step is 10 MHz
- **Up/Down Arrows** – change the center frequency by the step amount.

2.2.2 Span Controls

- **Span** – controls the frequency difference between the start and stop frequencies centered on the center frequency. A reduced span will be chosen if the new span causes the start or stop frequencies to fall outside the range of operation.
- **Zero Span** – Enters Zero-Span mode.
- **Full Span** – This will change the start, stop, center, and span frequencies to select the largest span possible.

2.2.3 Amplitude Controls

- **Ref Level** – sets the power level for the top graticule line. The units you select here will change which units are displayed throughout the entire system.
- **dB/div** – sets the scale for the y-axis. It may be set to any positive value. The chosen value represents the vertical height of one square on the graticule.
 - In linear mode, the dB/div control forces the system back into log mode with a displayed unit of dBm
- **Atten** – sets the internal electronic attenuator.
- **Lin** – changes the amplitude scale to linear and the displayed units to millivolts.

2.2.4 Bandwidth Controls

- **Res BW** – This controls the resolution bandwidth (RBW). For each span a range of resolution bandwidths may be used. The resolution bandwidth controls the FFT size and signal processing, similar to selecting the IF bandpass filters on an analog spectrum analyzer. The selectable bandwidths displayed change whether you want native or non-native bandwidths.
 - Native resolution bandwidths are available from below 1 Hz to 10.1 MHz, in powers of two.
 - Non-Native resolution bandwidths are available from 10 Hz to 10 MHz, in a 1-3 sequence. (e.g. 1 kHz, 3 kHz, 10 kHz, 30 kHz, 100 kHz, ...)
 - In Real-Time mode, only native bandwidth values are allowed ranging from 2.4 kHz to 631 kHz in powers of two.
- **Video BW** – This controls the Video Bandwidth (VBW). After the signal has been passed through the RBW filter, it is converted to an amplitude. This amplitude is then filtered by the Video Bandwidth filter.

- All Resolution Bandwidth choices are available as Video Bandwidths, with the constraint that VBW must be less than or equal to RBW.
- In Real-Time mode, Video Bandwidth is not selectable.

2.2.5 Marker Controls

- **Left-Right Arrows** – The marker controls give you access to 6 markers to use for accurate readings of sweeps. The left and right arrows scroll through the 6 markers changing the current active one. All marker controls affect only the active marker.
- **Peak Search** – This will place the active marker on the highest amplitude signal on the graticule.
- **Delta** – places a reference point where the marker currently resides. Once placed you can make measurements relative to the position of the reference point.
- **To Center Freq** – changes the center frequency to the frequency location of the current active marker.
- **Update On** – When Update is ON, the markers amplitude updates each sweep. When OFF, the markers amplitude does not update unless moved.
- **Off** – Disables the current marker, and hides it from the graticule.
- **To Ref Level** – changes the reference level to the amplitude of the active marker.

2.2.6 Trace Controls

- **Normal** – Toggles the display of the current sweep.
- **Average** – Toggles the display of averaged sweeps. The number of sweeps to be averaged is selectable upon enabling.
- **Max Hold** – When enabled, a max hold sweep maintains the highest amplitude for each frequency point. Each sweep, only frequency points with higher amplitudes are updated. Works simultaneously with Min Hold.
- **Min Hold** – When enabled, a min hold sweep maintains the lowest amplitude for each frequency point. Each sweep, only frequency points with lower amplitudes are updated. Works simultaneously with Max Hold

All sweeps toggled in the Trace Controls are able to be shown at the same time.

2.2.7 Trigger Controls

- **Single** – Request one more sweep from the Signal Hound before becoming inactive.
- **Continuous** – The software continuously requests sweeps from the Signal Hound.
- **Free Run** – In Zero Span mode, a sweep begins immediately.
- **Video** – In Zero Span mode, the Signal Hound waits for a minimum signal amplitude before sweeping. When clicked, a popup opens where the user sets the minimum signal amplitude. This is useful for measuring pulses as short as 10 microseconds.

2.2.8 Video Processing

- **Video Detector Settings** - As the video data is being processed, the minimum, maximum, and average amplitudes are being stored. You have a choice of which is to be displayed.

- **Video Processing Units** – In the system, unprocessed amplitude data may be represented as voltage, linear power, or logarithmic power. Select linear power for RMS power measurements. Logarithmic power is closest to a traditional spectrum analyzer in log scale.

2.2.9 Acquisition Controls

- **Sweep Time** – In Zero-Span mode, sweep time represents the total amount of time displayed in the graticule, rounded to the nearest sample. In sweep mode, Sweep Time is used to modify how long the BB60A dwells on each patch of spectrum. The actual sweep time may be significantly different from the time requested, depending on RBW, VBW, and span settings, as well as hardware limitations.
- **Spur Rejection** – When spur rejection is on additional signal processing is enabled attempting to remove spurious signals which are the result of mixing products. Spur rejection roughly doubles sweep time and is great for cleaning up a steady signal, but should not be used for pulsed RF. Spur rejection is not available in real-time mode.
- **IF Self Cal** – The BB60A device is temperature sensitive. The software updates these temperature calibrations when it sees a 2 °C change. To manually recalibrate the device for temperature changes at any time, use this button.
- **Gain** – Gain is used to control the input RF level. With this control you can have the gain determined automatically or choose 4 levels of gain. Higher gains increase RF levels. When gain is set to automatic, a best gain is chosen based on reference level. Manual gain settings may cause the signal to clip well below the reference level, and should be used by experienced BB60A users only.

2.2.10 Preset

- **Preset** – Restores the software and hardware to its initial power-on state by performing a device master reset.

2.3 The Menu

2.3.1 File Menu

- **Recall** – Begin playing a saved session. (See **Getting Started: Playback Toolbar**)
- **Save** – Begin recording a new session. (See **Getting Started: Playback Toolbar**)
- **Save as .bmp** – Save the current graticule view as a bitmap image.
- **Print** – Print the current graticule view. The resulting print will not include the control panel or the menu/toolbars.
- **Print Preview** – Shows you what will be printed using the print menu option.
- **Connect Device** – If no device is connected, this option will attempt to connect to the first BB60A device found.
- **Disconnect Device** – This option disconnects the currently connected BB60A device. This option combined with “Connect Device” is useful for cycling a devices power or swapping devices without closing the Signal Hound software.
- **Export→Trace CSV** – Saves the current visible trace as a CSV file.

- **Import→Path Loss Table** – This menu option allows you to introduce path loss corrections for the incoming traces. See **Additional Features : Importing Path Loss and Limit Line Tables** for more information.
- **Import→Limit Line Table** – Import a set of limit lines which then the incoming trace is tested against. Limit lines are two lines across the span which define an acceptable region for a trace. You can specify a maximum limit or a maximum and minimum set. See **Additional Features : Importing Path Loss and Limit Line Tables** for more information.

2.3.2 View Menu

- **Colors** – The colors menu provides the ability to change the graticule color scheme. Two color schemes are available, default(white on black), and printer friendly(black on white). If these are not to your liking, you can create a custom color scheme and tell the software to use your scheme for future application invocations.
- **Title** – Enable or disable a custom title. The title appears above the graticule and is included in screen captures via printing as well as session recordings.

2.3.3 Preferences

- **Window Type** – This menu option allows you to select between four windowing functions used in the signal processing. To have access to all four windowing function, you must be in sweep/time-gate mode and using native RBWs. In all other cases, the Nuttall window function will be used.
- **Spectrogram** – Preferences related to the two and three dimensional spectrogram displays.
 - **Color Blind** – Change between a color spectrum and black and white spectrum.
- **Persistence** – Preferences related to the persistence display. (See **Displays: Persistence** for more information regarding persistence)
 - **Decay Rate** – The decay rate determines how long a trace will impact the persistence display. Lower decay rates result in traces fading away slower, while higher decay rates result in traces fading quickly.
- **Trace Line Width** – Change the width of the trace lines. Affects all non-persistence and non-spectrogram traces.
- **Calibration** – Change whether temperature calibrations are made automatically during operation.

2.3.4 Presets

- **Save As** – Save the current device settings for later use.
- **Load** – Load a previously saved preset.

2.3.5 Settings

- **Reference Level Offset** – Adjust the displayed amplitude to compensate for an attenuator, probe, or preamplifier.
- **Downconverter Offset** – Apply a fixed frequency offset to the display and marker readout to compensate for your downconverter LO.

- **Sweep Time** – Adjust how long the device acquires data before processing. Processing time and memory usage increases as sweep time increases. Applies to sweep and zero-span modes only.
- **Real-Time Update Interval** – Change how long data is masked together in real-time mode before returning a trace.
- **Zero-Span Analysis** – Brings up a dialog allowing you to change zero-span settings.
 - **Trigger Type** – Choose between no trigger, video trigger, or an external trigger.
 - **Y Axis** – Change the demodulation type between AM and FM.
 - **Trigger Height** – Change the value on which a trigger becomes active.
 - **Trigger Time** – The maximum amount of time to look for a trigger for each sweep. If no trigger is found, the last possible section of the sweep is returned.
 - **Trigger Edge** – Determined whether to trigger on a rising or falling edge.
- **Time-Gate Analysis** – Brings up a dialog allowing you to change time-gate settings.
 - **Gate Length** – How much spectrum to analyze.
 - **Capture Length** – Amount of time to look for a trigger/gate.
 - **Gate Delay** – Amount of time between the trigger and the beginning of the gate.
 - **Trigger Edge Type** – Determine whether to trigger on a rising or falling edge.
- **RF Bypass** – N/A
- **Reference** – Change the source of the BB60A's reference oscillator. You can choose to use the internal reference or an attached 10MHz reference on the appropriate BNC port.

2.3.6 Spectrum Analysis

- **Idle** – Cause the device to enter an idle mode. No trace is displayed in this mode. Playback is possible in idle mode.
- **Swept Analysis** – Enter standard swept analysis.
- **Real-Time Analysis** – Enter real-time mode.
- **Zero-Span** – Enter zero-span mode.
- **Time-Gate Analysis** – Enter time-gate analysis.

2.3.7 Trace

- **Copy Trace** – Copy the currently displayed trace to one of two available copies.
- **Show Trace** – Toggle the display of the two trace copies.
- **Disable** – Disable the limit lines or path loss tables.
- **Persistence** – Enable/Disable/Clear the persistence trace.
- **Spectrogram** – Enable/Disable spectrogram display.
- **Signal Tracking** – Enable/Disable signal tracking.

2.3.8 Utilities

- **Channel Power** – Enable/Disable the channel power utility.

2.4 The Status Bar

The status bar runs across the bottom of the BB60A application. When the mouse enters the graticule the status bar displays the frequency/time value for the x-axis and the amplitude/frequency value for the

y-axis. The status bar readings should not be used for precise measurements, but is great for quick estimations.

2.5 Annunciator List

On the upper right hand corner of the graticule, you will find a list of annunciators. Annunciators are provided as warnings and indicators providing useful information to the operator. Below is a list of all annunciators and their meanings.

Temperature – The device temperature is always displayed in °C. This is the device’s internal temperature.

ADC – This indicator appears when hard compression is present on the displayed sweep. This occurs when the input RF signal reaches the maximum possible digital level. To fix this, you can increase the reference level, increase attenuation, or lower gain.

TEMP – This indicator appears when the device has deviated more than 2 °C since its last temperature calibration. The software will automatically calibrate under specific circumstances, the device is not in real-time mode and the user has selected the **Settings**→**Calibration**→**Auto** menu option (enabled by default). Manually recalibrate the device by pressing the **Self-Cal IF** control panel button.

LOW V – This indicator appears when the device is not receiving enough voltage from the USB 3.0 connection. The voltage value appears when this annunciator is present. The device requires 4.4V. If this annunciator appears, it may indicate other problems. Contact Test Equipment Plus if you are unable to determine the source of this problem.

UNCAL – This indicator appears whenever any warning indicator is active to notify the user that the device may not be meeting published specifications.

2.6 Playback Toolbar

The playback toolbar controls the recording and playback of sessions. Sessions are a collection of saved sweeps at one device setting.

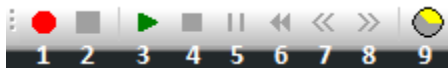

1. **Record** – Begins recording a session
2. **Stop Recording** – Stops recording an active session.
3. **Play/Continue** – Begin playing a saved session or continue a paused session.
4. **Stop** – Stop playing the current session.
5. **Pause** – Pause the current session.
6. **Rewind** – Rewinds then pauses the session.

7. **Step Back** – Shows the previous trace in the session and pauses.
8. **Step Forward** – Shows the next trace in the session and pauses.
9. **Timer** – Specify in milliseconds the amount of time to wait before displaying the next trace in the session, up to 2000ms.

3 Modes of Operation

The BB60A is a hybrid superheterodyne-FFT spectrum analyzer. The BB60A is a combination of swept-tuned and FFT based analyzers. The BB60A uses an oscillator and band-pass filter to down-convert a portion of the input spectrum into an intermediate frequency (IF). The intermediate frequency is then sent from the device to the host PC where it undergoes FFT spectrum analysis transforming the input IF into a frequency spectrum.

The IF resulting from the down-conversion contains 20 MHz of usable bandwidth.

The BB60A is also a real-time spectrum analyzer. This means the device is capable of continuously streaming a 20 MHz IF frequency with no time gaps. Having no time gaps is critical for measurements and tests requiring high probability of intercept (POI). See the section below **Real-Time Spectrum Analysis** for a more in-depth discussion of the BB60A capabilities.

The BB60A offers multiple modes of operation. Most of these are exposed in the software and others can be exposed through our C-based API. We will only cover those in our software here.

3.1 Swept Analysis

This mode of operation is the mode which is commonly associated with spectrum analyzers. Through the software you will configure the device and request the device perform a single sweep across your desired span. Since the BB60A has a max bandwidth of 20MHz, spans larger than 20MHz are the result of acquiring multiple 20MHz patches and concatenating the results of the FFT processing on each of these IFs.

The processing performed on each 20MHz patch is determined by the settings provided. Each time a trace is returned, the device waits until the next trace request. For you, the software user, you can choose to continuously retrieve traces or manually request them one at a time with the **Single** and **Continuous** buttons found on the **Trace Controls**.

3.2 Real-Time Spectrum Analysis

One of the issues with the standard sweep mode is the “blind time” between each trace. Blind time refers to the time between spectrum sampling. During this time, we are processing the last capture, or viewing the data. During this time it is possible to miss an event. The picture below shows a missed event in green.

MODES OF OPERATION

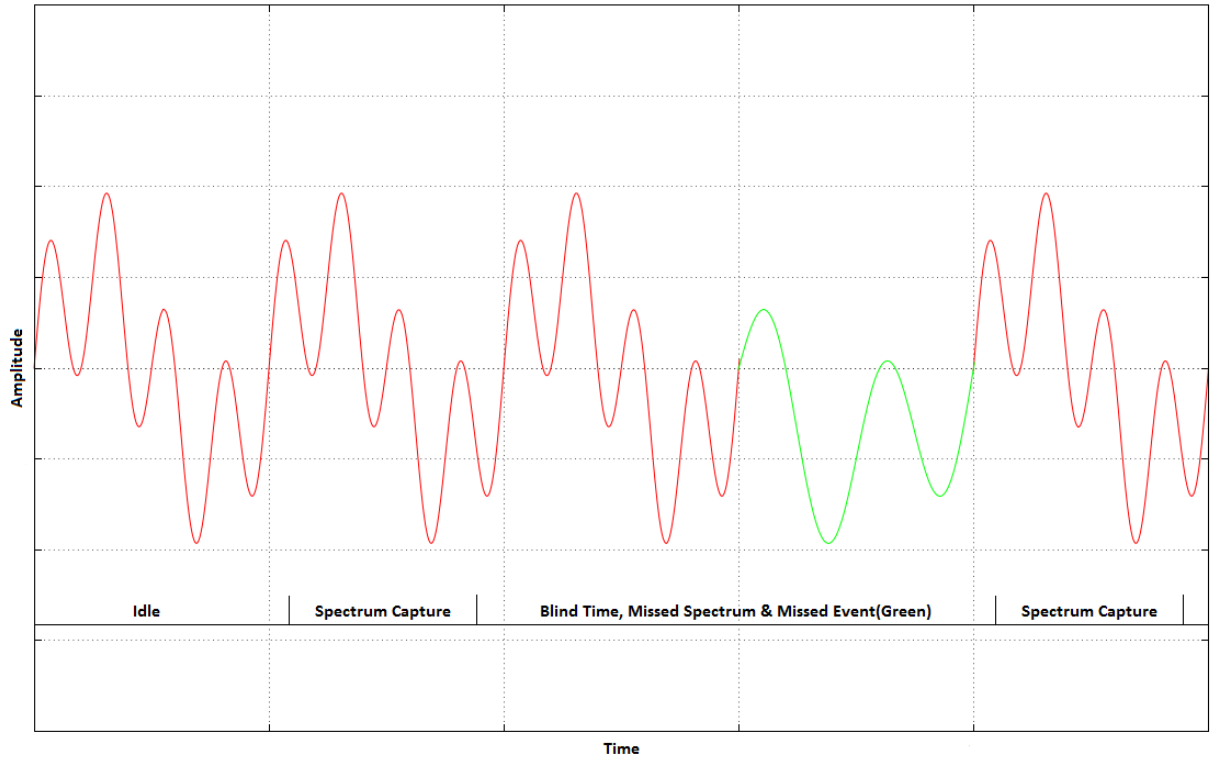

In this image we see an event missed due to the blind time between spectrum sampling. With Real-Time spectrum analysis we can prevent this and capture ALL possible events.

As discussed above, the BB60A is capable of streaming a 20MHz bandwidth with no time gaps. If we limit our spans to 20MHz we can now process every spectrum sample for our resulting trace. The BB60A performs overlapping FFTs at an overlapping rate of 75%, covering each point of data with 4 FFTs. We take the resulting FFTs and min/max them into a final returned trace. The number of FFT results merged depends on **Real-Time Sweep Time** and the **RBW**.

3.3 Zero-Span Analysis

Zero span allows you to view a signal in time domain. The y-axis can be either amplitude or frequency, and the x-axis is always time. Before entering zero-span analysis mode, modify your Zero Span Settings from the **Settings** menu.

Zero-span allows you to specify a video trigger, external trigger, or no trigger. Video triggers allow you to begin the sweep only after a signal exceeds the amplitude specified in “trigger height.” This is useful when you need to analyze a periodic transmission.

If your transmitter has a trigger output, you can route this to the BB60 **trigger in**. Select “external trigger” to cause the zero-span sweep to begin after this hardware trigger. You can trigger on the rising edge or falling edge of a signal. A 3.3V CMOS trigger with a 50 ohm output impedance is ideal, but 5V logic with a 50 ohm output impedance is acceptable. Higher or lower output impedance may work with a short BNC cable, but longer cables may cause issues with reflection.

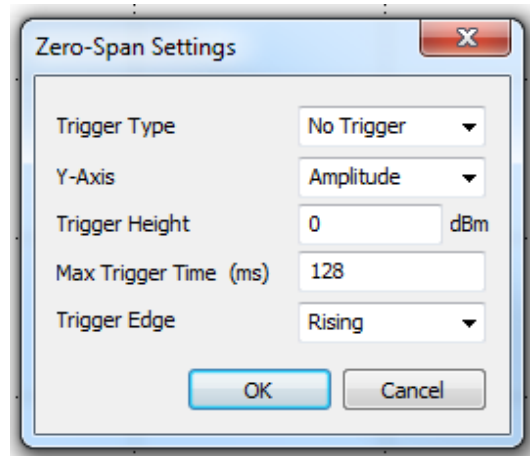

The sweep typically begins approximately 200 microseconds before the trigger event, allowing you to view a sliver of what was happening before the trigger. Do not use this zero span mode for precision timing applications. Please see the API manual for functions supporting precision time stamps.

The BB60 will wait up to a maximum of “Max Trigger Time” looking for a trigger. If none is found, it will automatically trigger at the end of the allotted time.

If your trigger output is sensitive to loading, start zero span mode before connecting your trigger, to ensure the BB60 trigger port is configured as an input.

3.4 Time-Gate Analysis

Time Gate analysis allows you to specify a time window in which the BB60A will measure the spectrum. With the use of an external input trigger you can define very precise time restrictions for spectrum analysis. Time Gate analysis is useful for synchronizing your transmitter duty cycle with your BB60 spectrum analyzer capture window, for example when you need to analyze a time-division multiplexed transmitter.

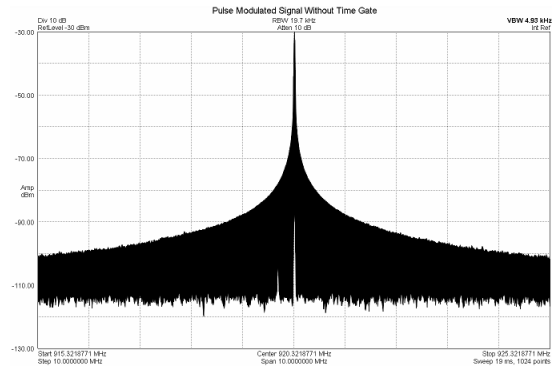

The above picture shows the spectrum of a pulse modulated signal without time-gate analysis. The picture, below, shows the same signal, time gated for when the transmitter is on.

In Time-Gate analysis the “gate” is referred to as the time period of interest. Ideally with an external trigger triggering before the gate of interest we can specify a few numbers to acquire our gate. We need to know the length of the gate and the amount of time after a trigger in which the gate occurs. The gate length must be large enough to perform the required FFT's based on your RBW and VBW. The software will notify you if a longer gate or higher RBW / VBW are required.

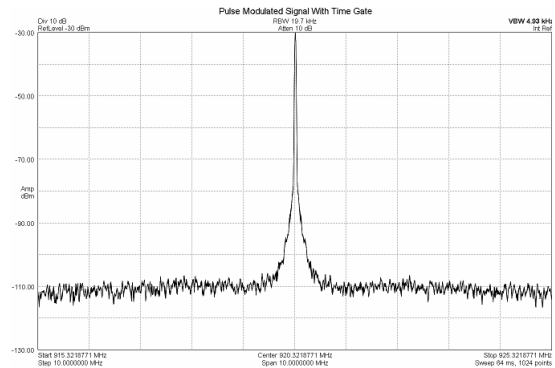

4 Taking Measurements

This section helps you learn how to measure, analyze, and record signals using the BB60A, utilizing built-in features such as markers, record/playback, and channel power.

4.1 Measuring Frequency and Amplitude

4.1.1 Using Markers

The BB60A software has several tools for identifying a signal's frequency and amplitude. The easiest to use is the **marker**. There are 9 markers available, each with its own reference.

To active and place a marker you can left click inside the graticule or press the **Peak Search** button on the marker controls to place the marker on the current trace peak and activate it simulatenously. Once a marker is active the frequency and amplitude readout of the marker is located below the graticule. The marker's accuracy is dependent on the span and RBW. Narrower spans and RBWs have higher marker accuracy. The amplitude accuracy is NOT dependent on the vertical dB/div, since the I/Q data is linear in voltage and has much higher resolution than is displayed. The marker may be re-placed at any time by clicking the graticule or by using the left and right arrows to shift the marker one sample point to the left or right.

4.1.2 Using the Delta Marker

To measure differences or changes in frequency and/or amplitude you can use the **delta** markers. To use the delta markers you must first create a reference point. With a marker active click the **Delta** control panel button. This places a reference location on the graticule. Now you can move the marker elsewhere on the graticule and the marker readings below the graticule will report the difference between the marker and the reference.

4.1.3 Measuring Low Level Signals

To measure low-level signals, there are a few tricks to getting accurate readings. First of all, set the internal electronic attenuator to 0 dB (click the atten button). Then, set your reference level to -50 dBm or lower. This internally selects the highest sensitivity settings. Using an external timebase and narrow span (1 KHz or less) should give you better results. Video averaging may be required for a stable amplitude reading.

4.2 Saving Sessions

The playback toolbar allows you to record and replay a continuous session up to 1GB. The length of the session will be dependent on the average sweep speed of the session and trace length. Sessions files have the extension “.b6p” and are named based on the current time and date. This naming scheme ensures no files are overwritten and relieves you of determining file names when you really want to capture a signal NOW. Pressing record on the playback tool bar causes the software to immediately begin recording. All playback files are saved in your “My Documents” folder.

When replaying all functionality of the software remains. You can place markers, activate min/max/average traces as well as view the recording using persistence and spectrogram views. In addition the playback toolbar allows you to pause, step, and rewind your way through a saved session.

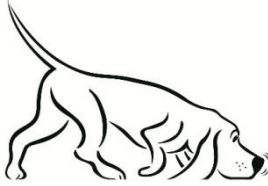

Tip: The title is also recorded and shown during playback. Use a title to describe the session!

4.3 Capturing Signals of Interest

CSV files can be created of traces using the File menu option. CSV files are useful for performing further signal analysis or plotting outside the Signal Hound application. When exporting a trace into a CSV file, the currently shown trace is exported. Because of this it may be difficult to obtain a CSV file of a signal of interest. For example, an intermittent signal which appears sporadically may be difficult to capture, or some modes such as Real-Time signal analysis are prohibited from saving CSV files.

One way to export a desired signal is to record the spectrum using the playback toolbar. If you are able to capture your signal in a playback session, you can playback the session and pause on your trace of choice. While paused you can export the trace.

Min and Max hold traces are another way to capture intermittent hard to view signals. Min and max hold keep track of the minimum and maximum values over a period of time storing them in a separate viewable trace. When min/max hold is active, markers automatically clamp to that trace.

4.4 Measuring Channel Power

The Utilities menu includes a Channel Power utility. When selected, a popup will appear requesting a channel bandwidth and channel spacing. Channel bandwidth is width in Hz of the band whose power you wish to measure. Channel spacing refers to the center-to-center frequency difference. Between channels, there is typically (but not always) a small guard band whose power is ignored.

For example, the image below shows a channel bandwidth of 180 kHz and spacing of 200 kHz. The image shows the FM station 101.1 in the center channel. Each channel will be integrated and the resulting power is display at the top of the channel.

The adjacent channels also show the channel power as well as the difference in power between the center channel and itself. In the example below the difference might be used to determine if any power is “leaking” into an adjacent FM band.

ADDITIONAL FEATURES

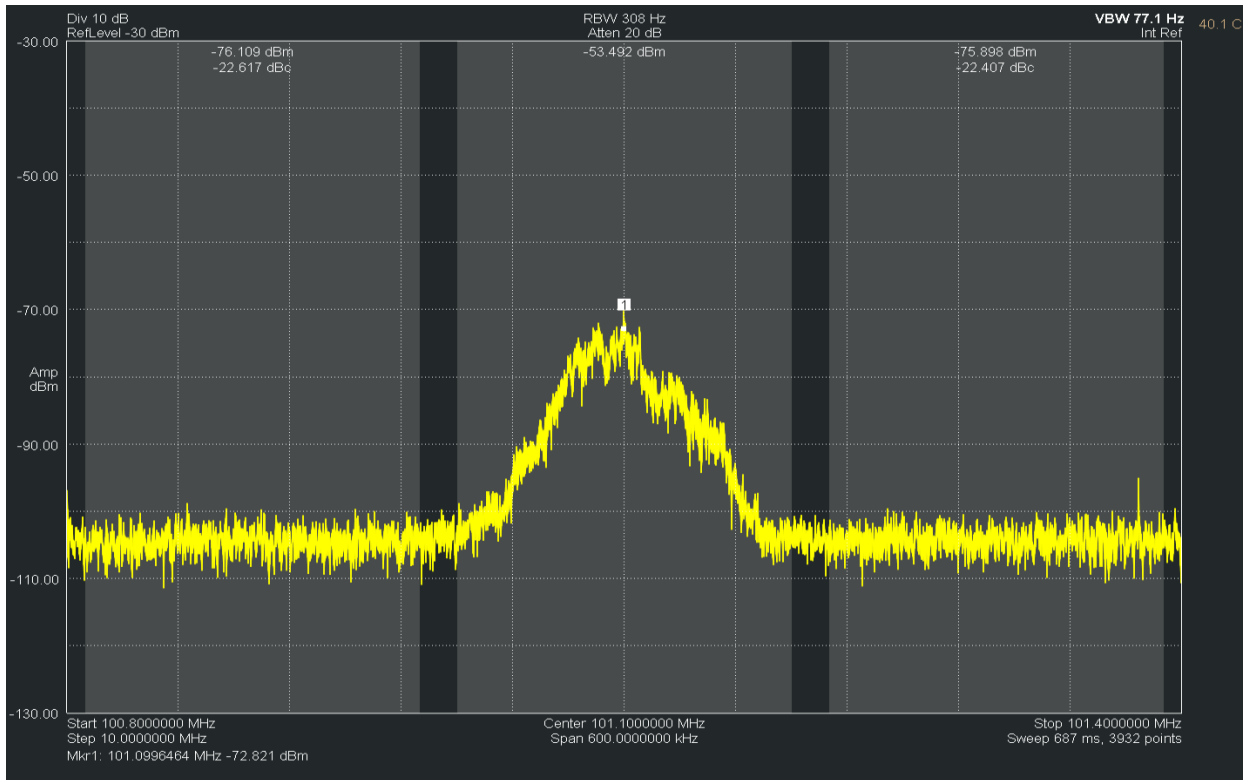

For best results, set your video processing to **AVERAGE**, **POWER**, and turn spur reject off. A native bandwidth must be selected for accurate power measurements. The software will set most of this up for you automatically.

5 Additional Features

The BB60A software has a number of useful utilities. They are described here.

5.1 Printing

Using the **File – Print** menu you can print exactly what is shown on the graticule. Be careful, if the software is still updating traces, you may not print the trace you wanted. Use the print preview option to see exactly what you will be printing.



Tip: The active color scheme is used for printing as well. Under the **View – Colors** menu, we provide a simple printer friendly color scheme to help you save ink!

5.2 Saving Images

Using the **File- Save as .bmp** menu option you can save the current graticule view as a bitmap image. The resulting resolution of the image is the exact resolution of your graticule when you choose to save. To obtain the highest resolution image, maximize the software and slide the control panel out of the way. The active color scheme is used in the resulting image.

5.3 Importing Path Loss and Limit Line Tables

Using the **File->Import** menu options you can import path loss and limit line tables from simple .csv files. CSV stands for Comma Separated Value. The format for a typical file might look like this..

```
23.56, 32  
123.45, 512  
...
```

Two or more values separated by a comma, each line ending with a carriage return. These files can be created with a simple text editor or spreadsheet program like Microsoft Excel.

For path loss tables we use a CSV file with two values per line. The first value on each line is a frequency value in MHz and the second value is a dBm offset. The frequency values must be in increasing order. The path loss corrections are linearly interpolated between these data points and are flat entering and leaving the span with the amplitude of the flat corrections being the first and last data point respectively. Here is an example of a path loss CSV file built in a spreadsheet program.

732	0
738	2

And here is the resulting path loss corrections applied to incoming traces for a 10MHz span centered at 735 MHz.

ADDITIONAL FEATURES

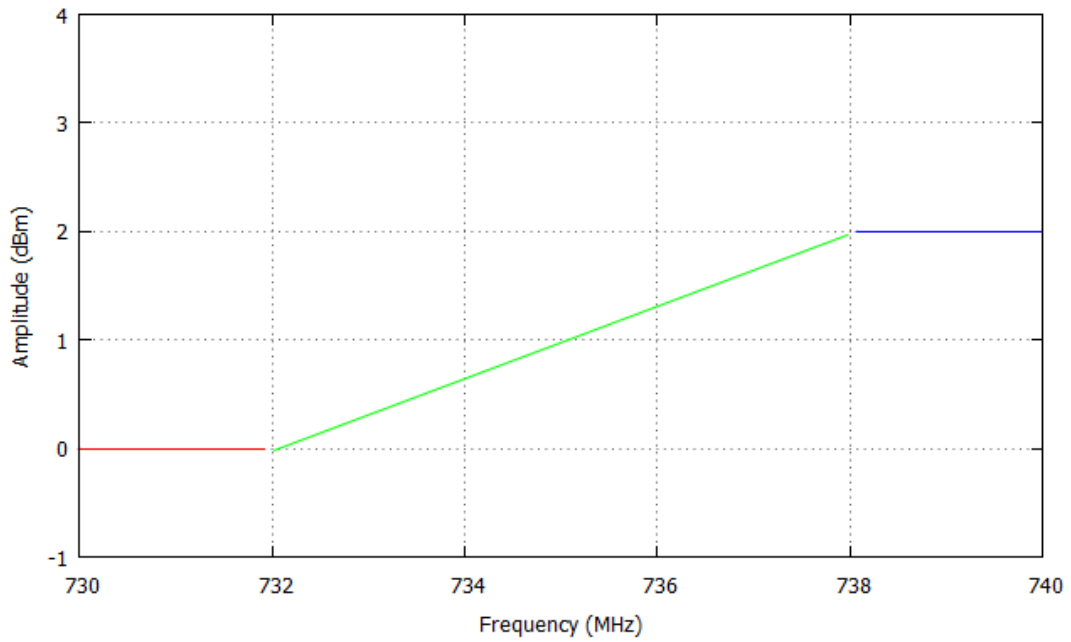

We can see the linear interpolation between the two points and flat lines off the sides.

The format for limit lines is very similar. Each line will contain two or three values. If you only want a max limit line, each line of the CSV will contain two values, if you want max and minimum limit lines, each line will contain three values. The first value will be a frequency in MHz, followed by the (optional) minimum amplitude in dBm, and the maximum amplitude in dBm.

The limit lines are drawn on the graticule and every trace is tested against them. Indicator text will appear in the center of the screen denoting whether the trace currently shown passes or fails the limit line test.

6 Display Modes

The BB60A provides you with many ways to view the spectrum. Each type of display is useful for different purposes. Below is an introduction to some of the views.

6.1 Spectrogram

The BB60A offers two visual representations of a spectrogram, the traditional spectral waterfall and a three dimensional representation where amplitude is represented by color and height. Our spectrogram displays show spectral history of up to 128 sweeps. Below is an image of the spectral waterfall displaying an FM station broadcasting with HD radio. The width of the view is representative of the selected span. The colors along a horizontal line represent the amplitude of that given sweep. More recent sweeps appear at the front (bottom) of the display. Low amplitudes are represented by blue, and as amplitude increases, the color moves through the color spectrum, from blue to green to red.

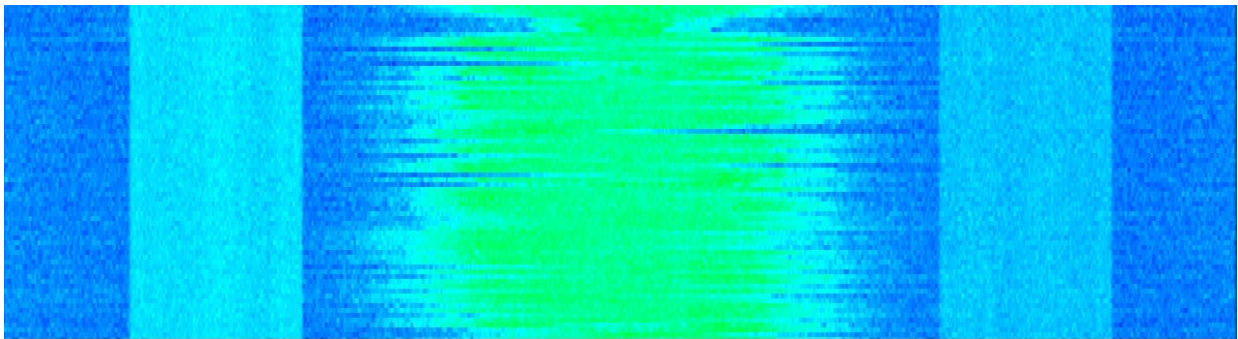

Figure 2 : FM Station with HD Radio side bands

6.2 Persistence

The BB60A persistence display is helpful for viewing spectral density over time. Instead of showing a single trace, persistence uses the last ‘n’ traces to create an image where color is representative of how often a signal appears. The software uses the color spectrum to represent density over time. If a signal rarely occurs in a location, a light blue is used to color the trace. If a signal continues to appear in the same location the color will change from blue to green to red. Red is an indication of a signal persisting in one location for a good deal of time. Using the **Preferences → Persistence → Decay Rate** menu option, you can control how fast traces accumulate on the screen.

DISPLAY MODES

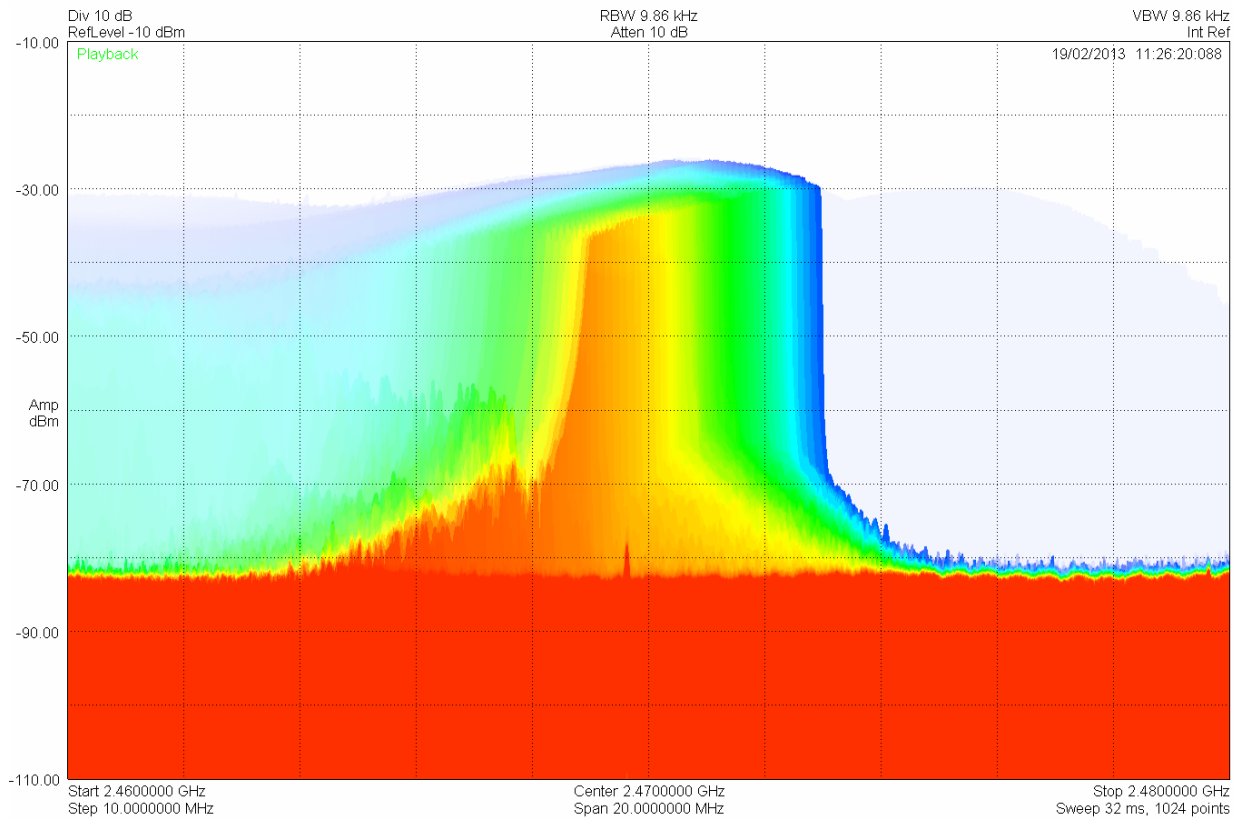
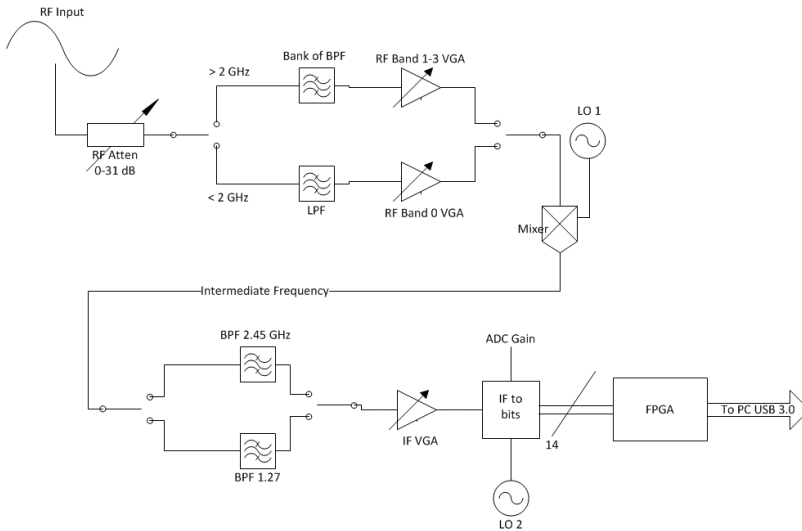

Figure 3: Persistence showing the signal from a poorly shielded commercial microwave oven in Real-Time mode.

7 Understanding the BB60A Hardware

7.1 Front End Architecture



The AC-coupled RF input is first attenuated. It then passes through a band select filter to reject the image and out-of-band responses, after which it is amplified or attenuated before mixing (a gain setting of 1 or less attenuates the RF).

At the mixer, a local oscillator is injected high-side to produce the intermediate frequency (IF). This IF is either ~ 2.35 GHz, or ~ 1.27 GHz, depending on band. The IF passes through a SAW filter with approx. 60 MHz of bandwidth,

and is then amplified or attenuated (a gain of 0 attenuates the IF). The SAW filters were selected to have good rejection 280 MHz from center.

Inside the IF-to-bits subassembly, the IF is mixed to 140 MHz (the image 280 MHz away having been filtered out in the previous step), filtered to a 20 MHz bandwidth, then digitized at 80 MSPS. Additional gain may be applied in the IF-to-bits subassembly when gain is set to 3.

7.2 Spurious Signals

A spurious signal appears as a function of an input signal. These include signals from intermodulation, image responses, local oscillator spurs, and ADC aliasing.

Spurious signals from intermodulation can be controlled by limiting the amount of power into a mixer or amplifier. Decreasing the power by 10 dB will often reduce intermodulation products by 20 or 30 dB.

One source of image-related spurious signals comes from the image from the first mixer. These are usually far from the signal of interest and very low in amplitude, especially below 2 GHz, but may be something like -40 dBc in small areas of the upper bands. These spurs will be rejected using the software “spur reject.”

Another source of spurs occurs when LO1 exceeds 4.4 GHz. The LO is doubled in this case, introducing spurs from the LO subharmonic. This is especially noticeable when you are sweeping across 5.7 GHz, as a signal injected at 4 GHz will create a false spur which may be something like -28 dBc from the actual signal. These spurs will be rejected using the software “spur reject.”

Other spurs may occur 280 MHz below the actual signal, from the IF filter rejection. These are usually quite low.

Finally, some spurs are introduced during the final mixing and digitizing. Anything not rejected by the final 140 MHz may be aliased into the data, specifically signals 30-50 MHz above and below the desired signal. These are typically about -50 dBc, but may be higher near gain compression. These will generally be rejected by using the software “spur reject,” but there are some exceptions, especially even multiples of 10 MHz.

For spans below 500 kHz and some streaming and zero-span modes, additional spurs from the fractional-N local oscillator may be observed. These will usually be below -50 dBc, and will generally be rejected by using the software “spur reject.”

7.3 Residual Signals

A residual signal appears even when there is no signal input. The BB60A has noticeable residual signals at multiples of its 10 MHz timebase. These are guaranteed to be below -90 dBm for a reference level of -50 dBm, attenuator 0 dB (for advanced users, 0 dB atten, gain of 2 or 3), but will typically be well below this level. For higher reference levels or lower gain, these may be higher. If these residual signals interfere with your signal measurements, an external RF amplifier may be needed.

7.4 Amplitude Accuracy

Some of the filters are temperature-sensitive. We have included an automatic self-calibration when a significant temperature change is observed. If this is turned off, a temperature change may introduce amplitude ripple in the passband, increasing measurement error by a dB or more in some cases. Because of this, bypassing the automatic self-cal is not recommended when amplitude accuracy is important.

7.4.1 Scalping Loss

The “native” bandwidths used in the BB60A come directly from the windowed FFT results. When a signal falls between two “bins,” the energy is split between adjacent bins such that the reported “peak” amplitude may be lower by as much as 0.8 dB. If frequency resolution and processing speed are more important than absolute amplitude, use native bandwidths.

To get an accurate power reading using “Marker peak”, non-native bandwidths are recommended. They integrate the power across several adjacent bins, eliminating scalping loss.

The “channel power” utility, which integrates the power across any channel bandwidth you specify, also eliminates this scalping loss.

7.5 Dynamic Range

The BB60A software will automatically select internal gain settings for best dynamic range when the input signal is equal to reference level, given your selected attenuator setting. You may notice, as you increase reference level, the noise floor suddenly jump up. This is from a step in the internal gain setting.

These gain steps may be 20 dB or more in some cases. Because of this, increasing or decreasing your attenuator setting by 10 dB may allow the software to select a more optimal gain setting, significantly improving your dynamic range.

For large spans crossing multiple bands, you may notice a step in the noise floor. This is due to different sensitivities and gain settings for each band. Changing your reference level or attenuator setting by 10 dB may reduce this step if desired.

Advanced API users gathering uncorrected data with the BB60A have an additional tool for optimizing dynamic range, as the uncorrected data is referenced to full scale ADC readings. In most gain settings, the best compromise between dynamic range and spurious is achieved when the signal is reading -10 to -20 dB Full Scale (dBFS). Simply choose an appropriate gain and fine tune your attenuator setting to optimize for your needs.

8 Troubleshooting

If you experience a problem with your Signal Hound, please try these troubleshooting techniques before contacting us.

8.1 Unable to Find or Open the Device

Ensure the device is plugged in and the green light is on. If it is not, unplug then plug in the device. Once the green light turns on, use the **File** menu to try to connect the device again.

8.1.1 The Device Light is Green and Still Won't Connect

This is often the case when the device is plugged in when a PC has been turned on. We recommend leaving the device unplugged when you turn off your PC. If this is the case, a power cycle will solve this issue.

8.1.2 A Power Cycle Does Not Fix the Problem

If a power cycle still does not allow you to connect the device, it is possible the device drivers were not successfully installed. See the **Driver Installation** section for information about the BB60A drivers.

8.2 The Signal Hound is Not Sweeping Properly

If the sweeps shown are not what you expect there are a number of things you can try.

- 1) In the preset menu, **Load->Factory Settings** will return the application to default start up settings. This might be useful if you managed to change a setting and can't undo it.
- 2) Restarting the application is a quick way to reset any unknown settings or state.
- 3) The green **Preset** button located on the control panel performs a hard reset for the device and the software settings. In rare instances, communication between the application and device can become corrupted. The **preset** button should be used any time the device enters an undesirable state.

8.2.1 The Sweep is not Updating

When the BB60A is unplugged from the USB 3.0 port while operating, the software may continue looping through the last sweep in some modes. To rectify this, plug the BB60 back in and click **Preset**.

8.3 The Device is Not Valid

In the event the device ceases to operate or becomes corrupted, the application might tell you the device does not appear to be valid. Before contacting us, attempt to power cycle the device and restart your computer to ensure nothing else is causing this issue. If the issue persists, please contact us.

9 Calibration and Adjustment

Contact Test Equipment Plus for more information regarding calibration software and required equipment.

10 Specifications

10.1 Frequency:

Range: 9 kHz to 6.0 GHz
Streaming IF or I/Q data: 20 MHz real-time analysis BW
Resolution Bandwidths (RBW): 10 Hz to 10 MHz
Internal Timebase Accuracy: ± 1 ppm per year

10.2 Sweep Rate

Sweep Speed (RBW \geq 9.86 kHz):
("Spur Reject" off) ≥ 24 GHz/sec
("Spur Reject" on) ≥ 12 GHz/sec

Note: Non-native bandwidths or lower VBWs will result in slower sweep speeds. Sweep speed does not count sweep setup time (typically <20 ms)

10.3 Amplitude (RBW \leq 100kHz, IF auto-cal on)

Range: +10 dBm to Displayed Average Noise Level (DANL)
Absolute Accuracy*: ± 2.0 dB

Displayed Average Noise Level (dBm/Hz), reference level -60 dBm, atten 0 dB:

9 kHz to 100 kHz	-123
100 kHz to 200 kHz	-132
200 kHz to 300 kHz	-142
300 kHz to 6 GHz	-152

Residual Responses (includes 10 MHz timebase multiples):

(≤ -50 dBm Ref Level, 0 dB Atten) -90 dBm

LO Leakage: ≤ -65 dBm

Please note: native bandwidths have additional "scalping loss" of up to 0.8 dB. Use non-native (1/3/10) bandwidths or the channel power tool for critical amplitude measurements.

*Device must be plugged in for at least 5 minutes to guarantee amplitude accuracy.

SPECIFICATIONS

10.4 Spectral Purity

Spurious & Image Rejection (-20 dBFS into ADC, 0dB attn., max gain) typical:

SW Spur Reject	9 kHz to 1.5 GHz	1.5 GHz to 5.0 GHz	5.0 GHz to 6.0 GHz
Off	-39 dBc	-37 dBc	-22 dBc
On	-39 dBc	-46 dBc	-48 dBc

Phase noise at 1 GHz:

Frequency Offset	dBc/Hz
100 Hz	-70
1 kHz	-78
10 kHz	-84
100 kHz	-96
1 MHz	-116

LO Leakage: ≤ -65 dBm out the RF input connector

10.5 Timing

External Trigger: ± 50 nS (4 samples)

GPS Synchronization: 1-PPS GPS precision time stamping

Accuracy: ± 50 nS (4 samples) plus GPS error

10.6 Environmental

Operating Temperature: 32°F to 122°F (0°C to +50°C) without derating specifications

Typical internal temperature is 15°C above ambient. Internal temperature is not to exceed 70°C while operating.

Size and Weight:

7.63" x 3.19" x 1.19" (194mm x 81mm x 30mm)

Net, 0.69 lb. (0.31 kg)

11 Warranty and Disclaimer

©Copyright 2013

Test Equipment Plus

All rights reserved

Reproduction, adaptation, or translation without prior written permission is prohibited, except as allowed under the copyright laws.

11.1 Warranty

The information contained in this manual is subject to change without notice. Test Equipment Plus makes no warranty of any kind with regard to this material, including, but not limited to, the implied warranties or merchantability and fitness for a particular purpose.

Test Equipment Plus shall not be liable for errors contained herein or for incidental or consequential damages in connection with the furnishing, performance, or use of this material. This Test Equipment Plus product has a warranty against defects in material and workmanship for a period of one year from date of shipment. During the warranty period, Test Equipment Plus will, at its option, either repair or replace products that prove to be defective.

11.2 Warranty Service

For warranty service or repair, this product must be returned to Test Equipment Plus. The Buyer shall pay shipping charges to Test Equipment Plus and Test Equipment Plus shall pay UPS Ground, or equivalent, shipping charges to return the product to the Buyer. However, the Buyer shall pay all shipping charges, duties, and taxes, to and from Test Equipment Plus, for products returned from another country.

11.3 Limitation of Warranty

The foregoing warranty shall not apply to defects resulting from improper use by the Buyer, Buyer-supplied software or interfacing, unauthorized modification or misuse, operation outside of the environmental specifications for the product. No other warranty is expressed or implied. Test Equipment Plus specifically disclaims the implied warranties or merchantability and fitness for a particular purpose.

11.4 Exclusive Remedies

The remedies provided herein are the Buyer's sole and exclusive remedies. Test Equipment Plus shall not be liable for any direct, indirect, special, incidental, or consequential damages, whether based on contract, tort, or any other legal theory.

11.5 Certification

Test Equipment Plus certifies that, at the time of shipment, this product conformed to its published specifications.

11.6 Credit Notice

Windows is a registered trademark of Microsoft Corporation in the United States and other countries.
Intel® and Core™ are trademarks or registered trademarks of the Intel Corp. in the USA and/or other countries.